

Г. ШТЕЙНГАУЗ

МАТЕМАТИЧЕСКИЙ КАЛЕЙДОСКОП

Приложения:

- 1) МАСШТАБНАЯ ЛИНЕЙКА (к № 21)
- 2) ЛОНГИМЕТР (к № 45)
- 3) БИОСКОП (к №№ 49, 50, 64)
- 4) ТОР (к № 117)
- 5) ДИСК (к № 124)

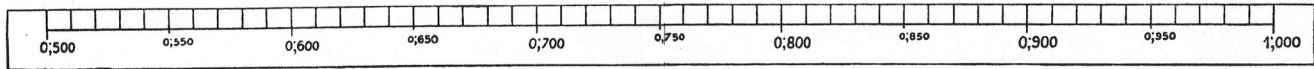

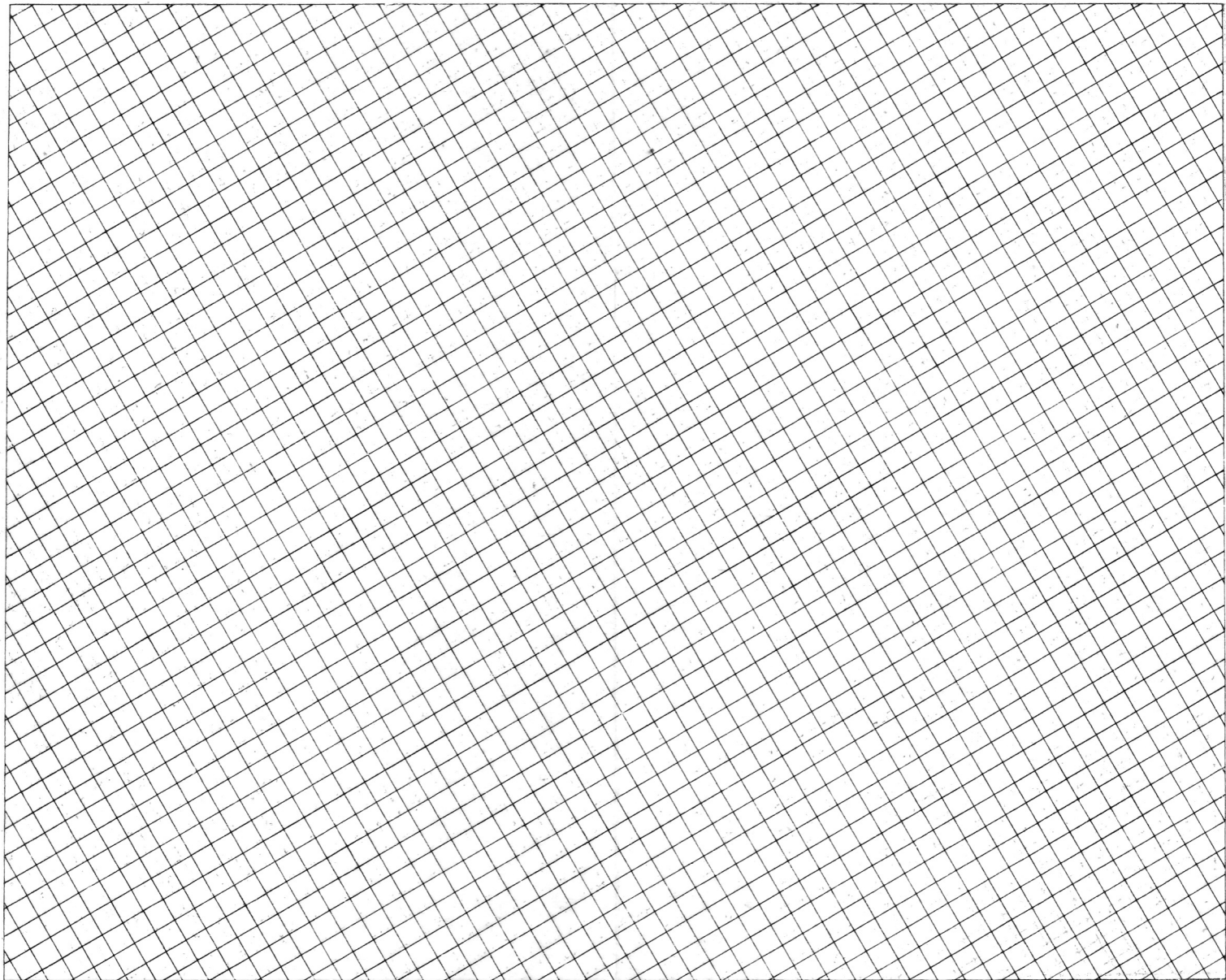

БИОСКОП

Вырезать все карты биоскопа по контуру, сложить их в карточную колоду по порядку номеров (сверху – № 1, под ним – № 2 и т. д., кончая № 31) и, для удобства хранения и пользования, обхватить всю колоду (поперёк) тонкой „аптечной“ резинкой

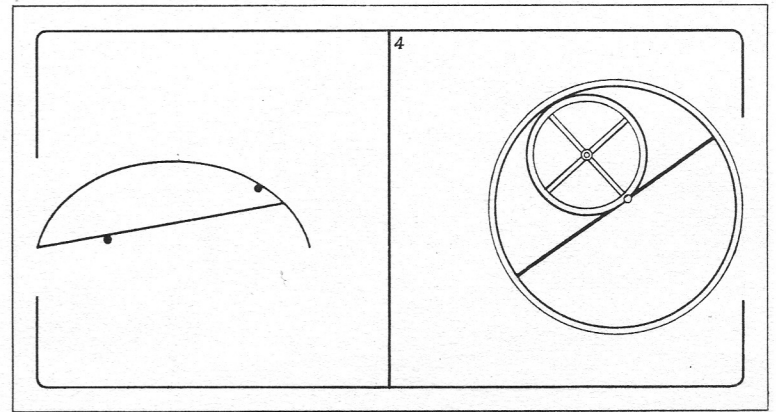
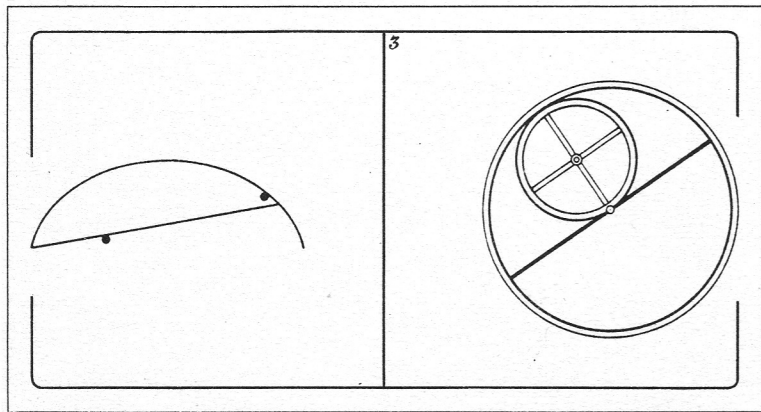
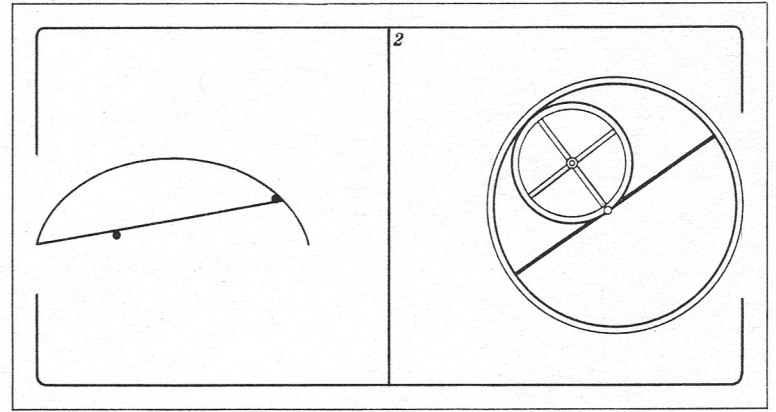
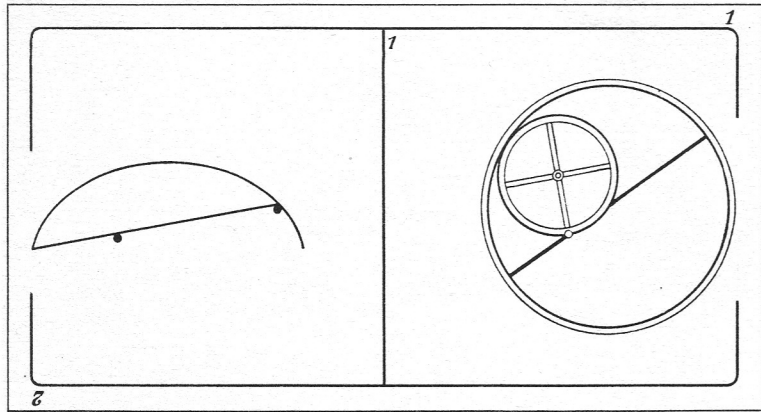

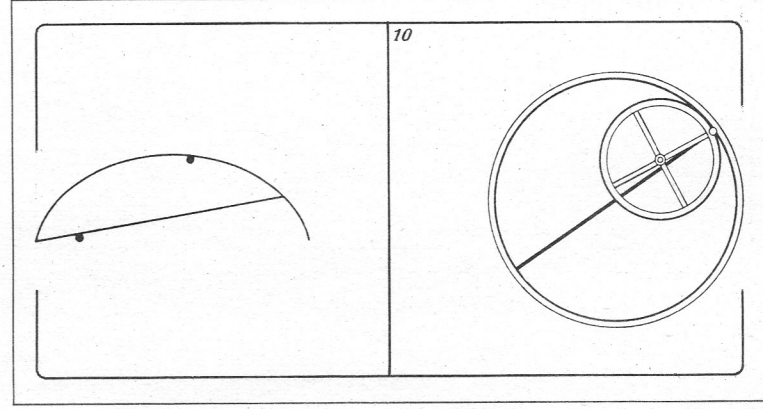
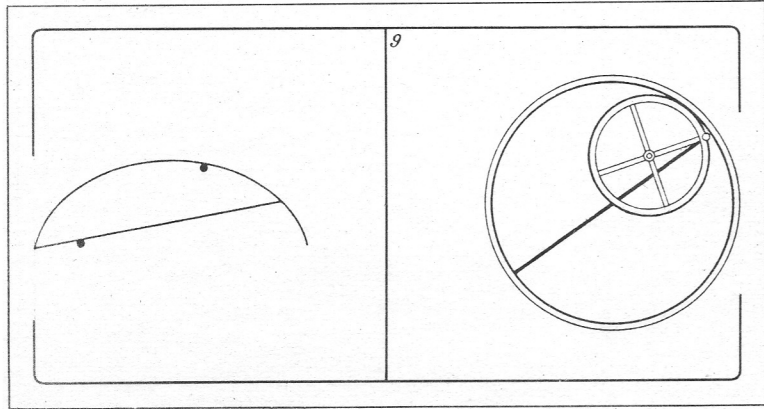
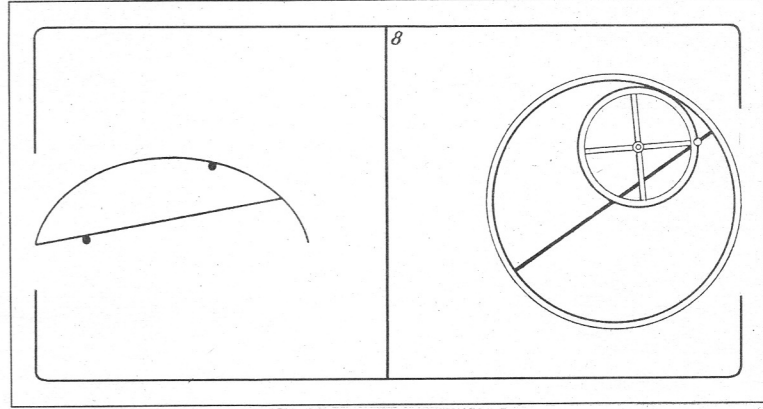
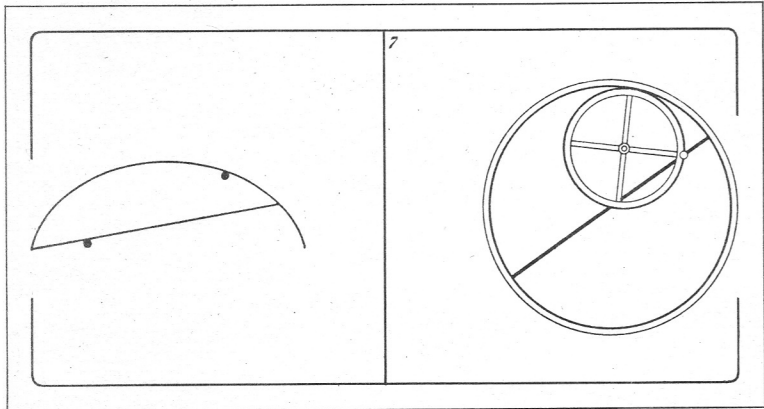
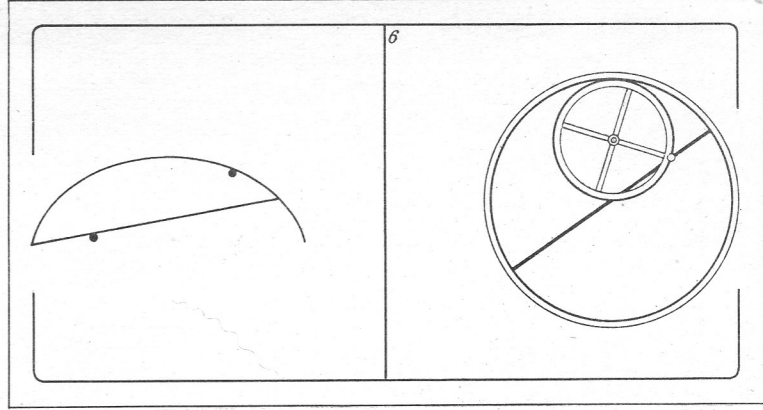
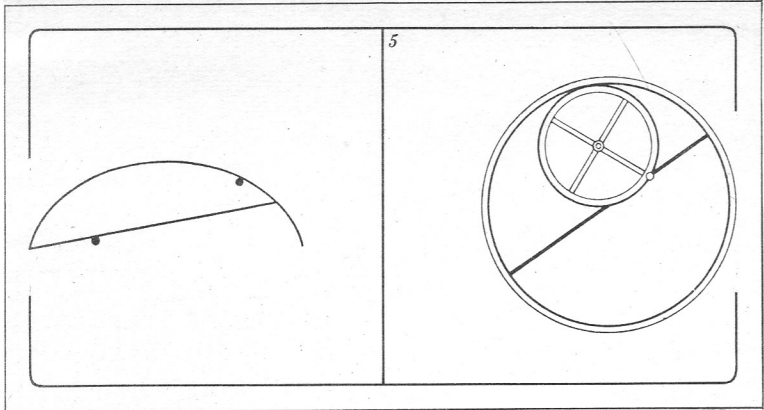

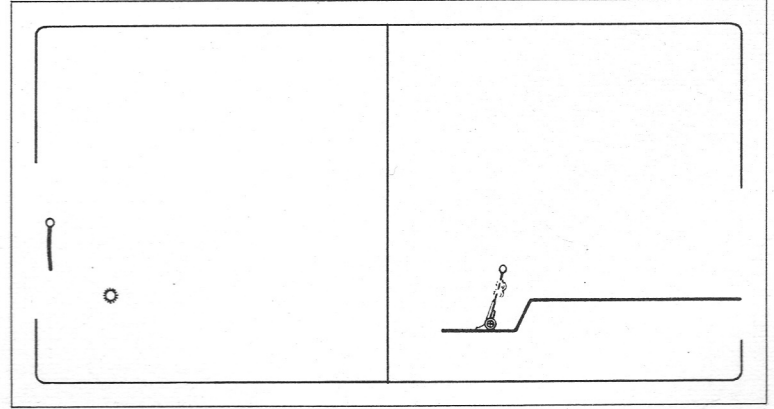
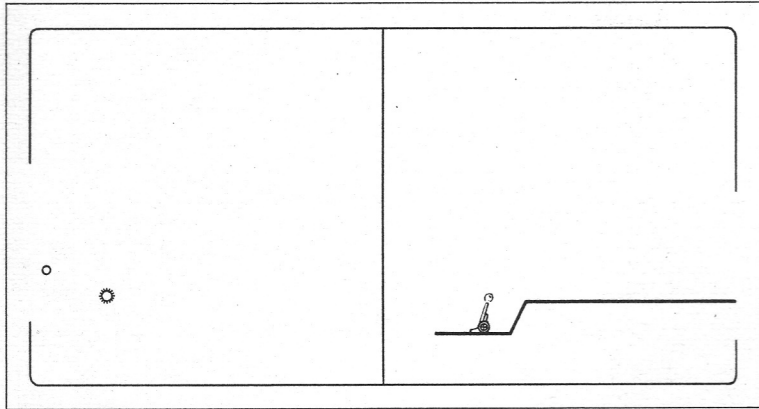
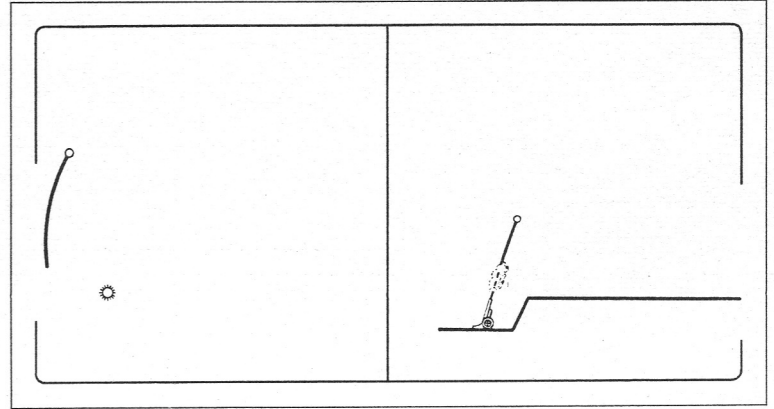
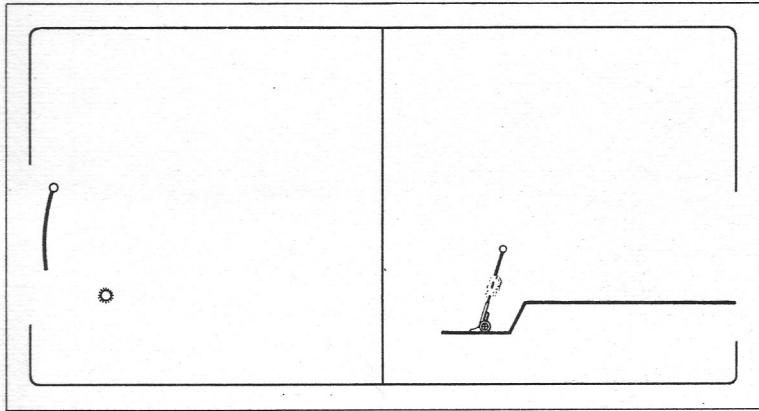

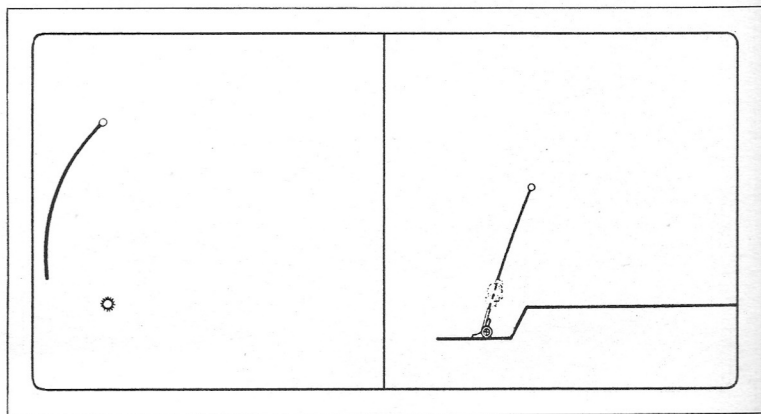
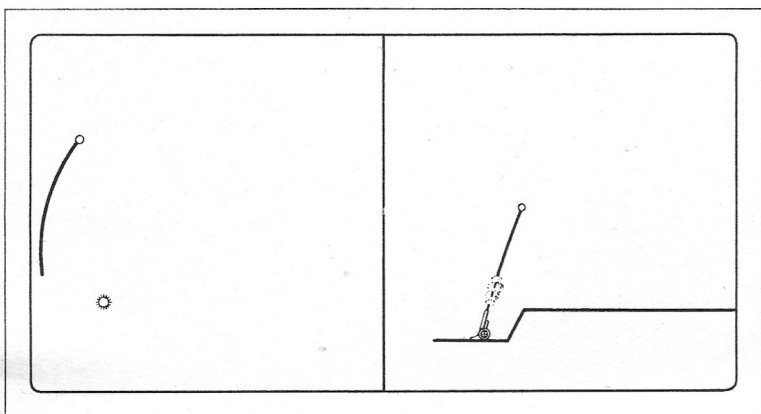
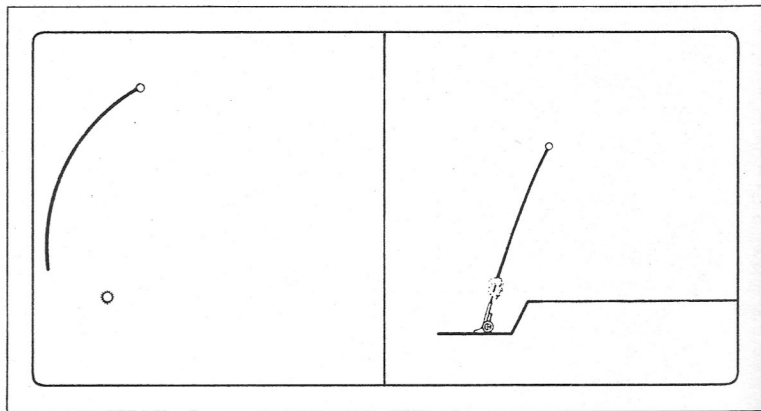
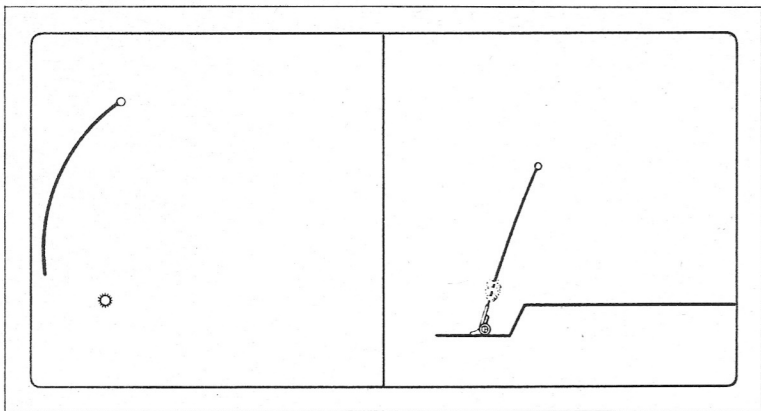
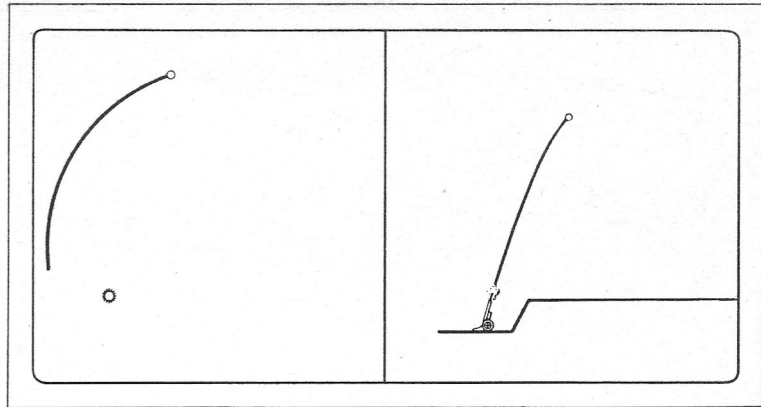
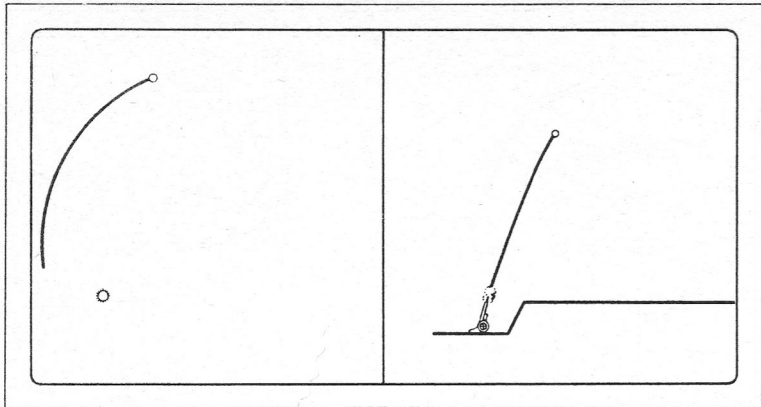

11

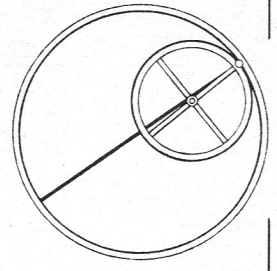
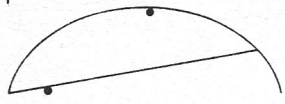

12

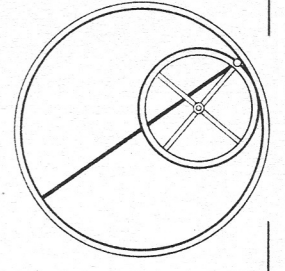
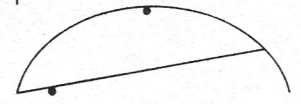

13

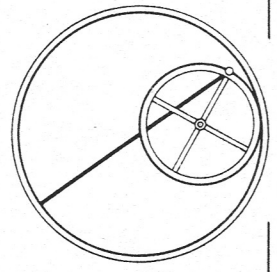
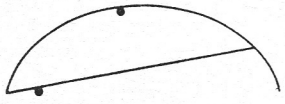

14

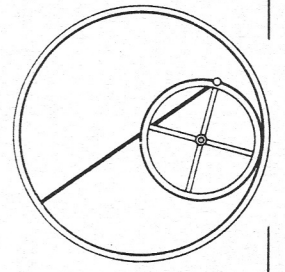
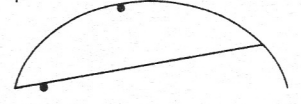

15

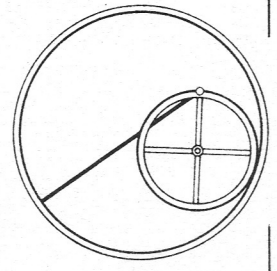
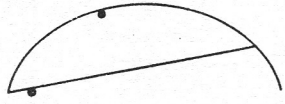

16

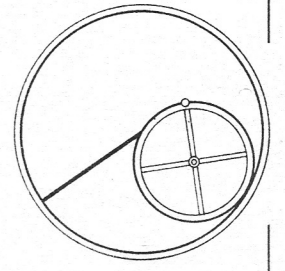

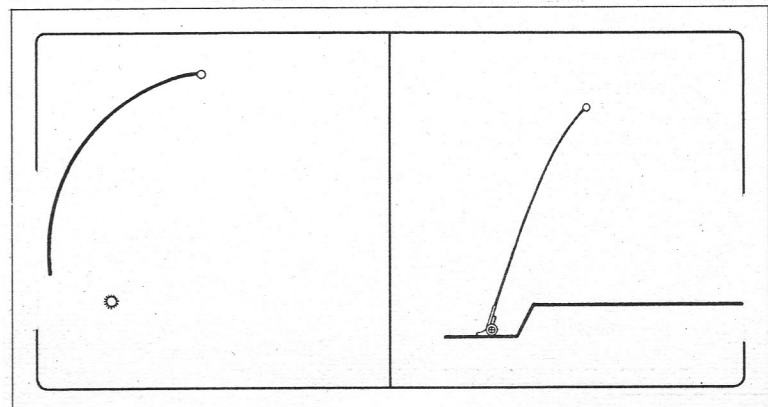
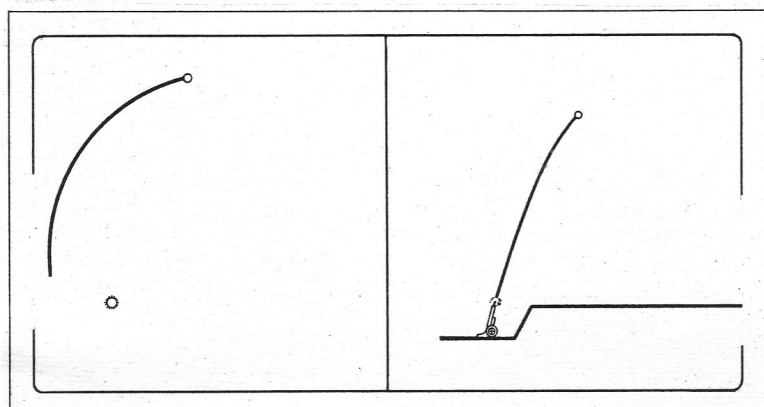
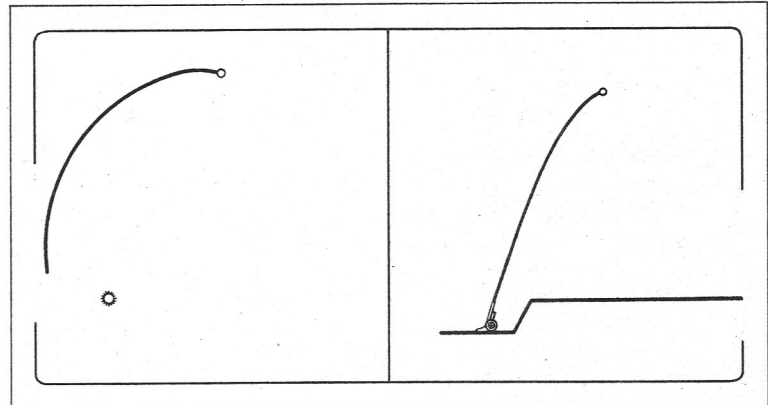
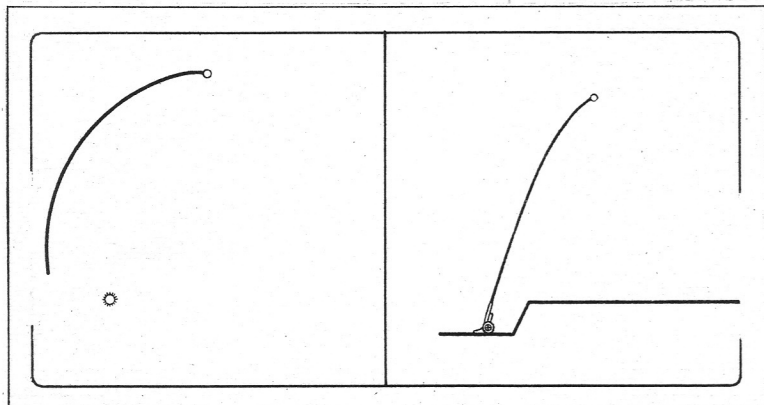
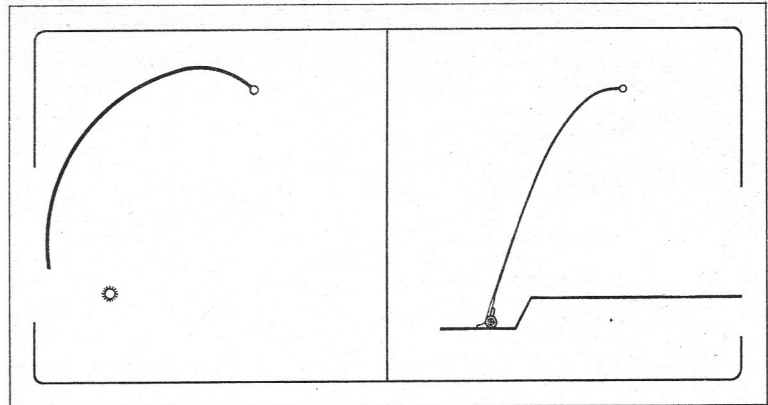
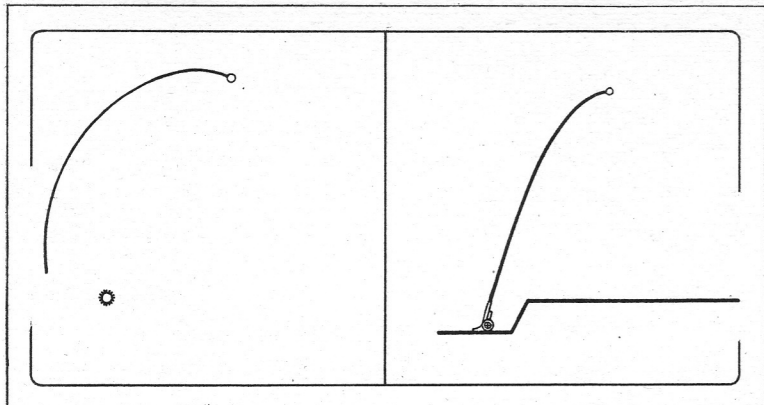

17

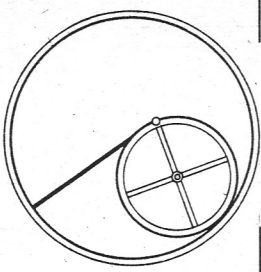

18

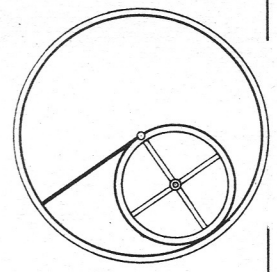

19

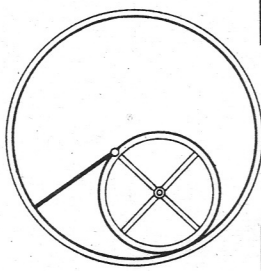

20

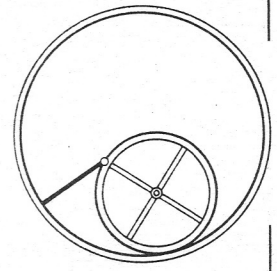

21

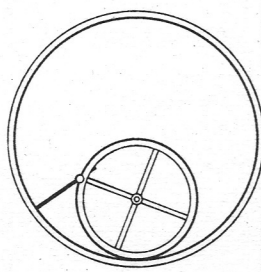

22

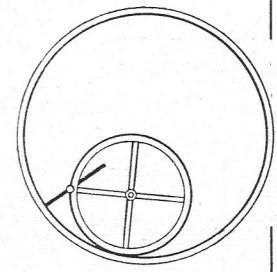

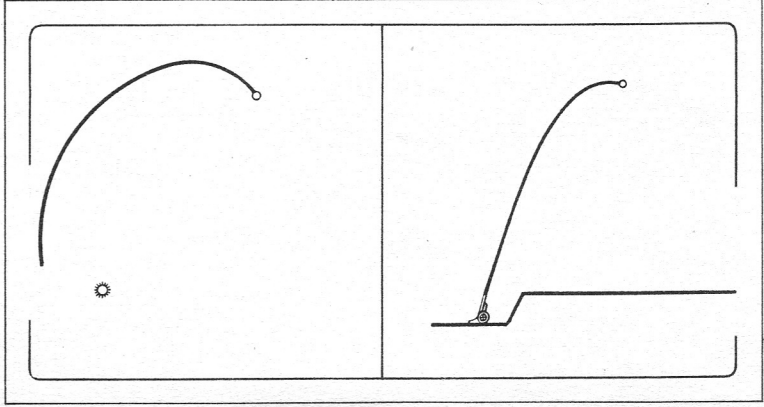
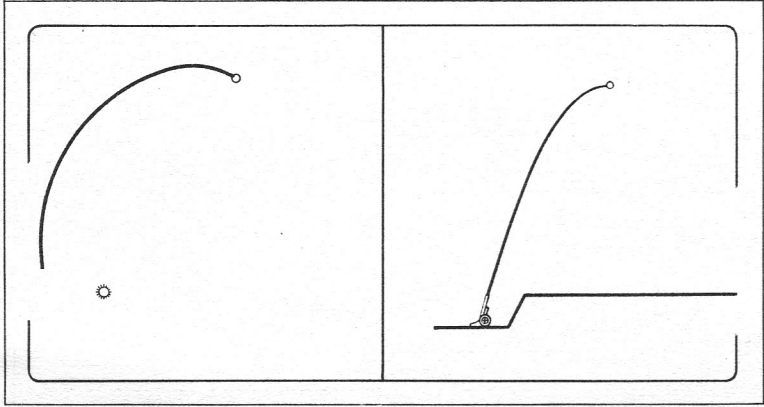
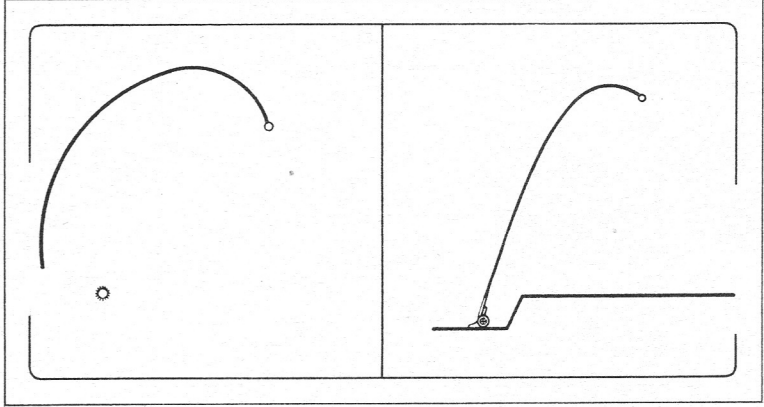
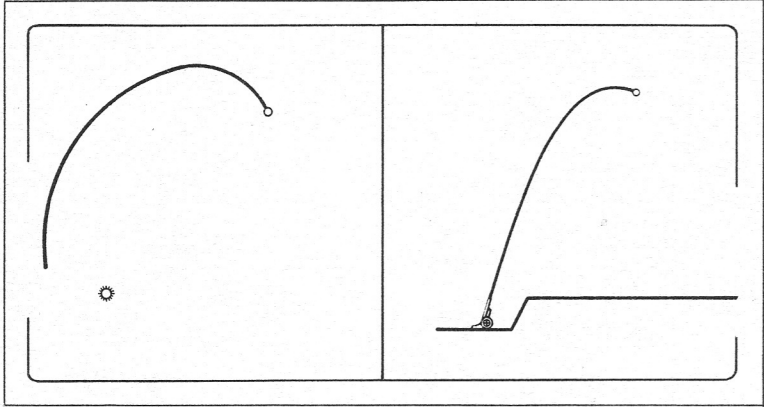
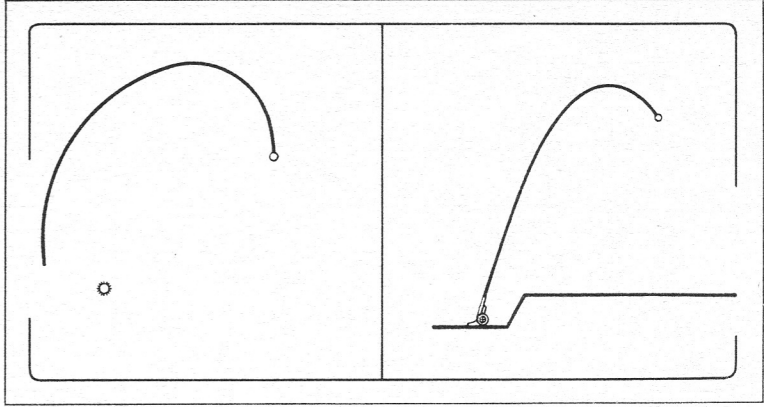
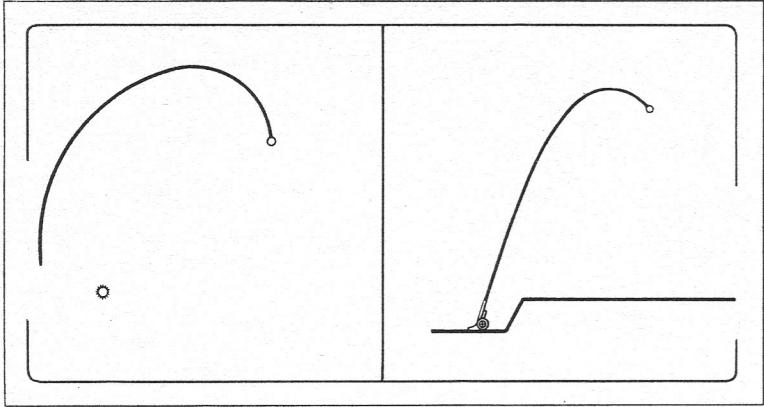

23

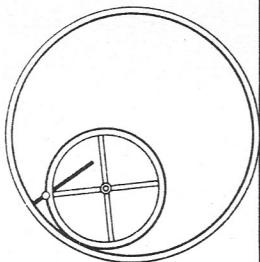

24

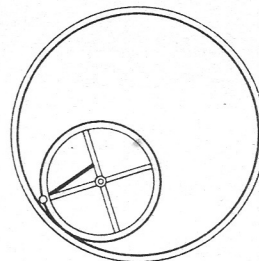

25

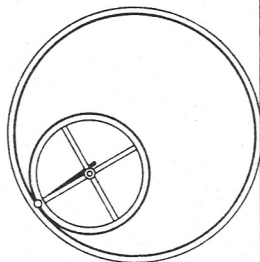

26

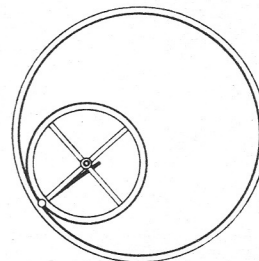

27

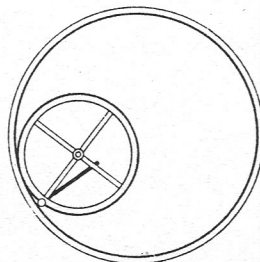
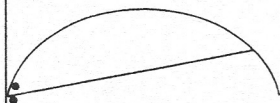

28

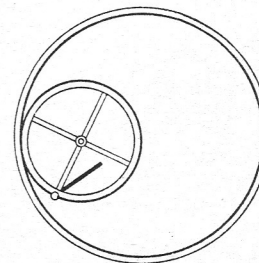

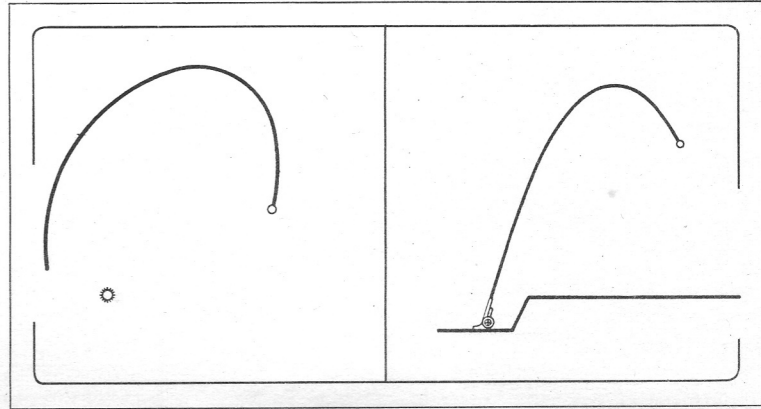
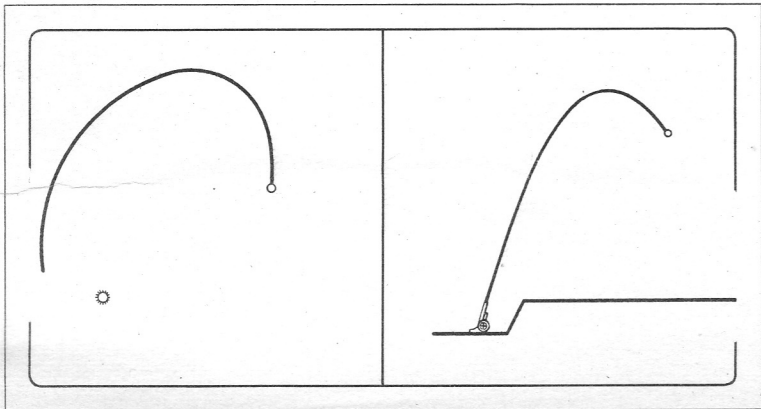
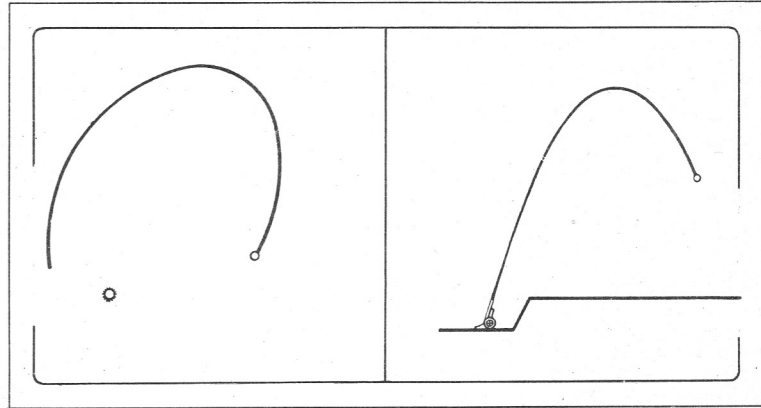
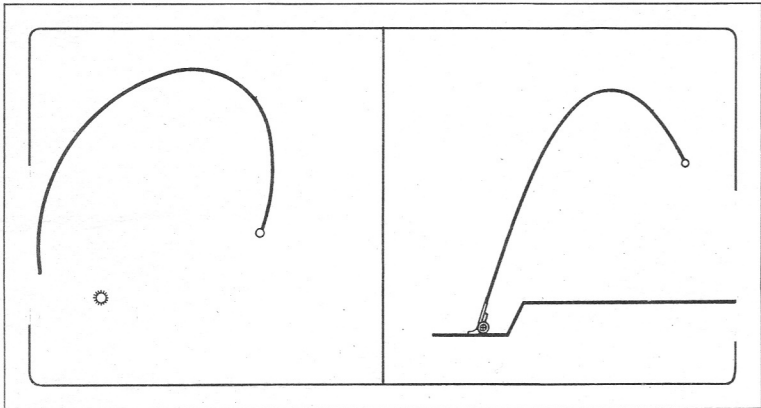
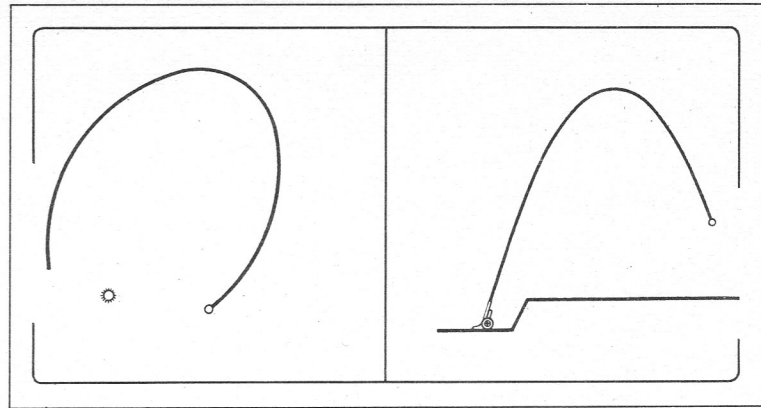
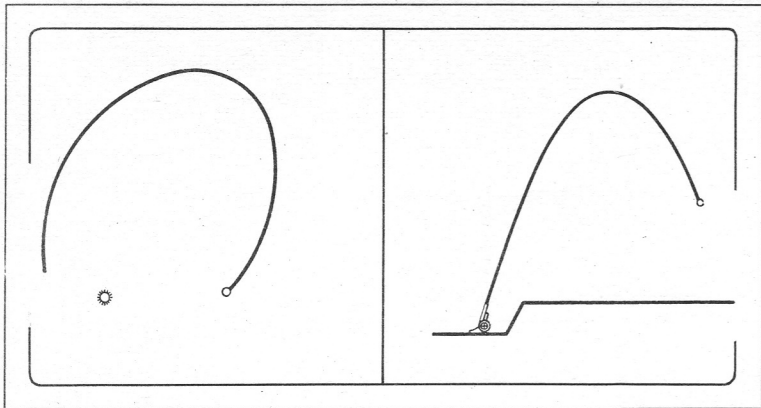

29

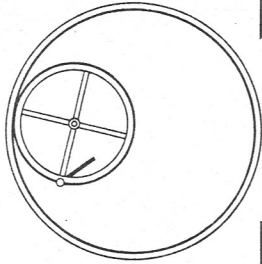

30

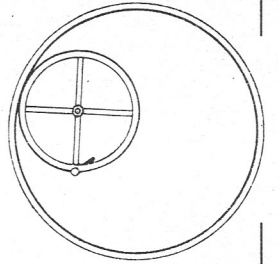

31

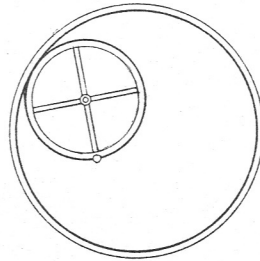

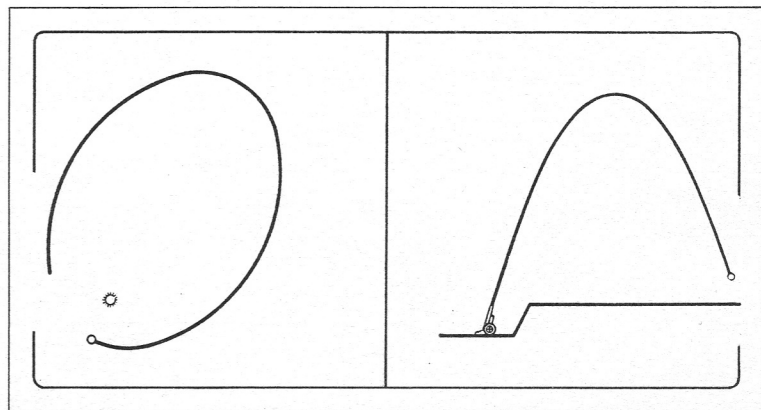
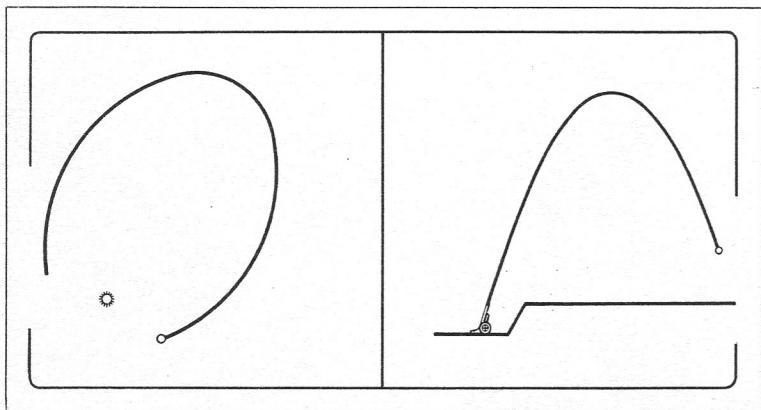
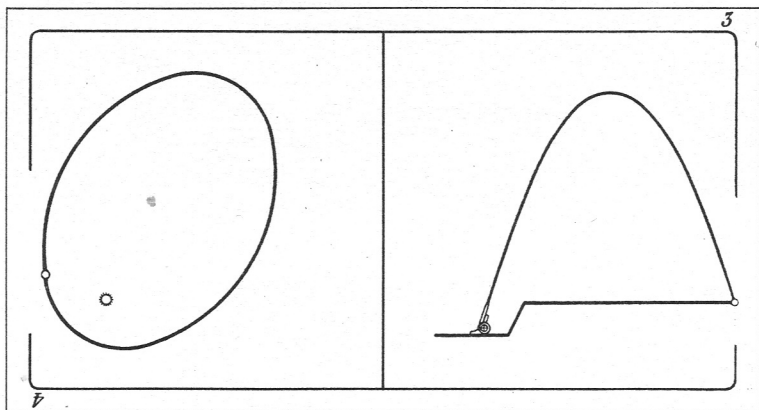

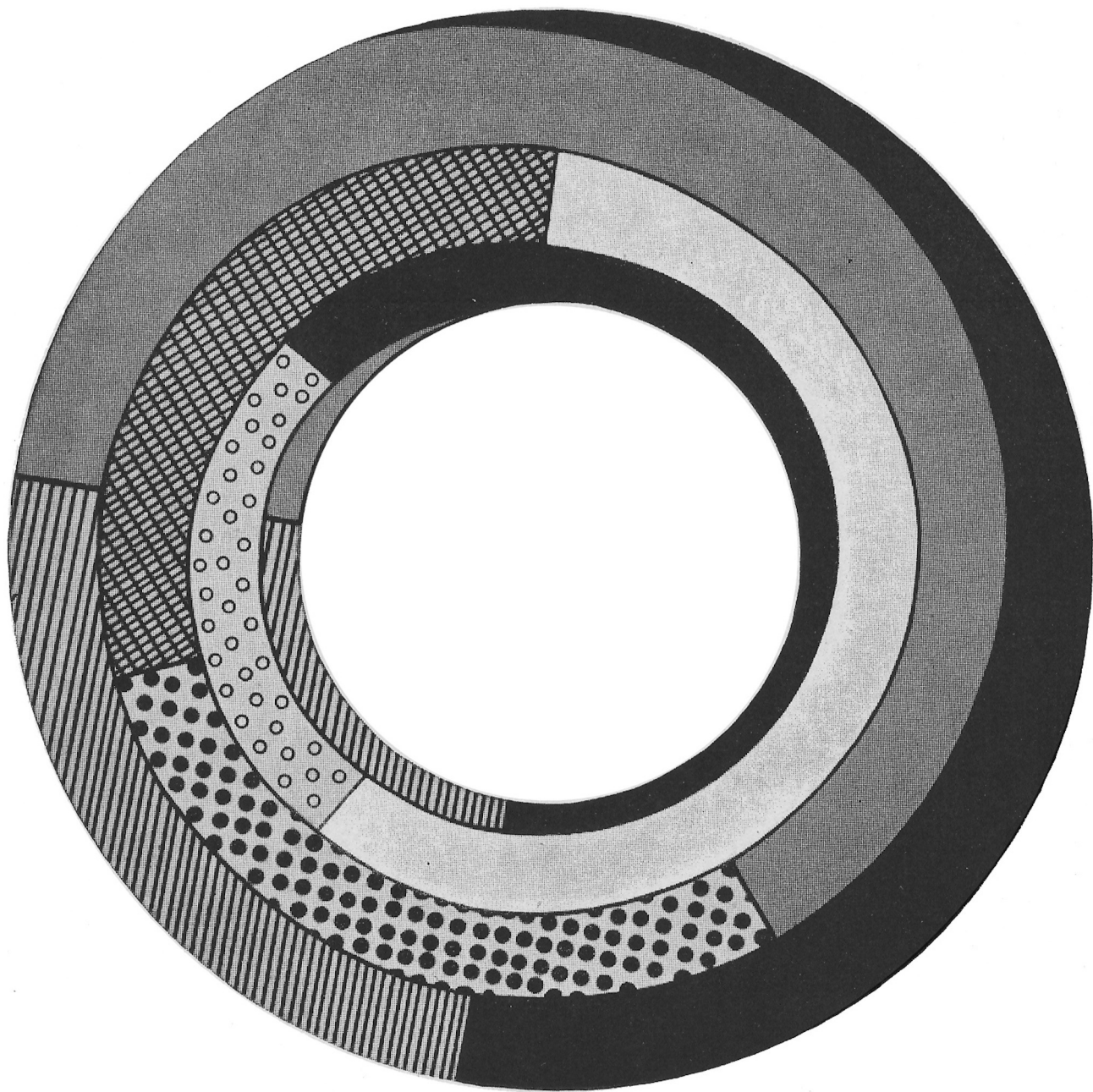

КАРТОННАЯ МОДЕЛЬ ТОРА

Вырезать по наружному контуру,
а также вырезать внутренний белый круг

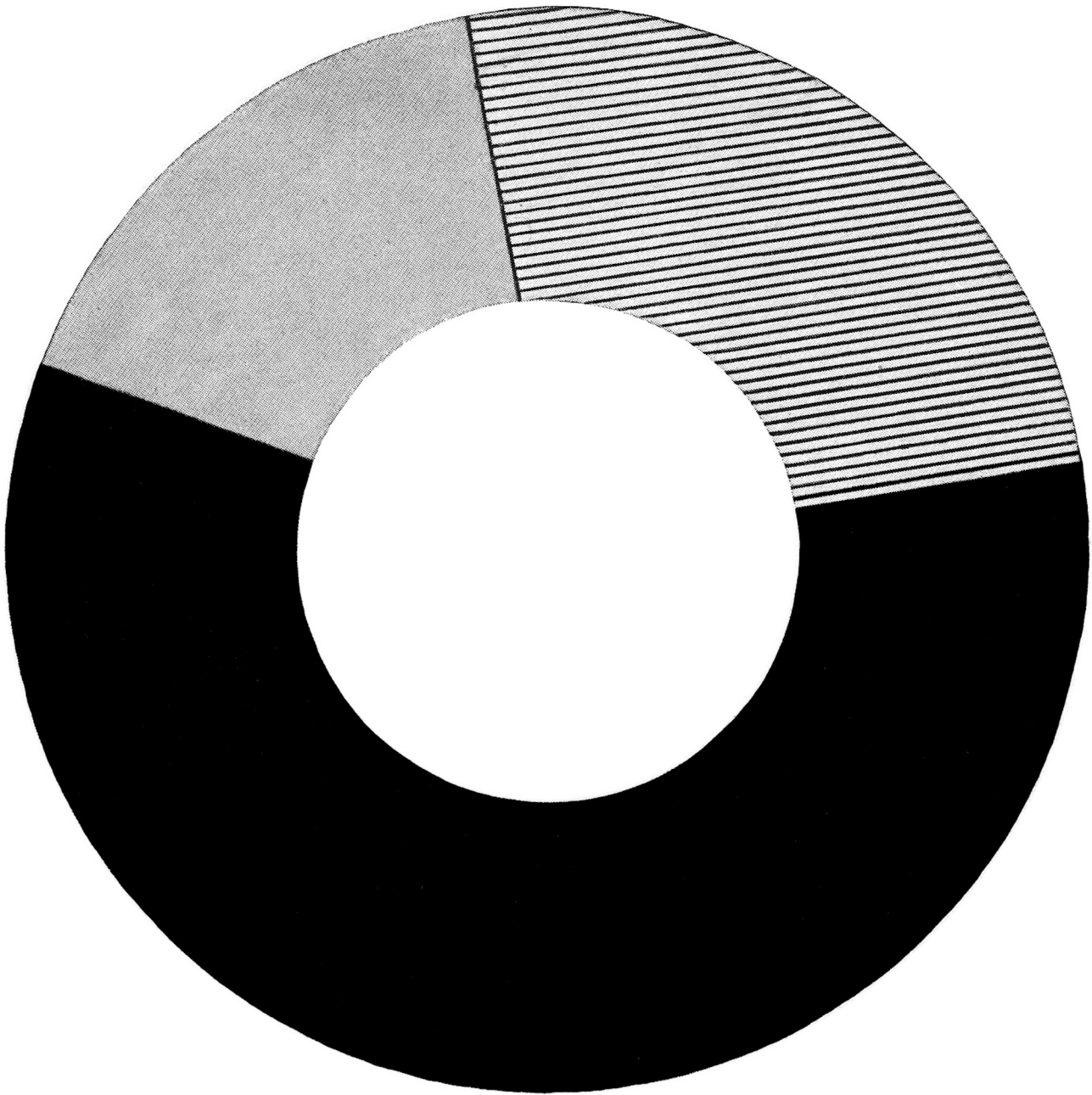

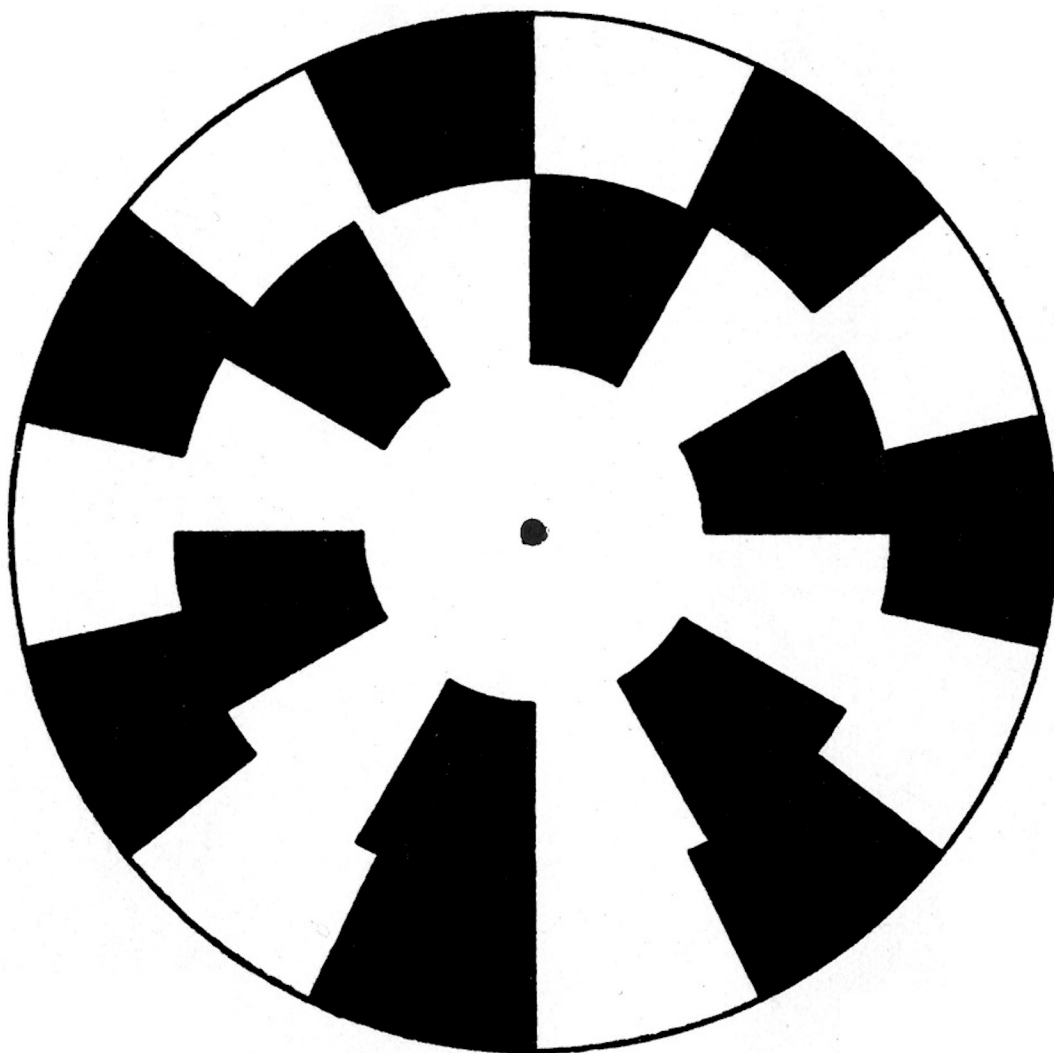

КАРТОННЫЙ ДИСК

Вырезать по контуру
и проколоть в центре